

 PELLET AIR

# CHARLY 7/9 CHARLY GLASS 7/9

Stufa ermetica con uscita fumi superiore coassiale. Disponibile nella versione in acciaio verniciato, o con rivestimento in vetro nella versione Charly Glass. Grazie alla forma arrotondata, può essere installata anche ad angolo.

Poêle étanche avec sortie des fumées par le haut en concentrique. Ce modèle existe avec revêtement en acier verni (Charly) ou avec revêtement en verre (Charly Glass). Poêle rond qui peut être installé dans un angle.

Estufa hermética con salida de humos superior coaxial. Disponible en la versión en acero pintado, o con revestimiento en vidrio en la versión Charly Glass. Gracias a la forma redondeada, puede instalarse también en ángulo.





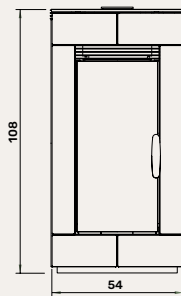









# CHARLY 7/9 CHARLY GLASS 7/9



CHARLY / CHARLY GLASS	7	9
<b>CLASSE ENERGETICA</b> Classe énergétique - Clase energética	<b>A<sup>++</sup></b>	<b>A<sup>+</sup></b>
<b>POTENZA NOMINALE</b> Puissance nominale - Potencia nominal	<b>6,1 kW</b>	<b>8,2 kW</b>
<b>DIMENSIONI</b> Dimensions - Dimensiones	<b>54 x 60,4 x 108 cm</b>	
<b>PESO STUFA</b> Poids poêle - Peso estufa	<b>100 / 108 kg</b>	<b>100 / 108 kg</b>
<b>RENDIMENTO</b> Rendement - Rendimiento	<b>min 93,8 % max 93,1%</b>	<b>93,3 % 91,7 %</b>
<b>CONSUMO ORARIO</b> Consommation horaire - Consumo horario	<b>min 0,54 kg/h max 1,35 kg/h</b>	<b>0,54 kg/h 1,83 kg/h</b>
<b>AUTONOMIA</b> Autonomie - Autonomía	<b>min 29 h max 12 h</b>	<b>29 h 9 h</b>
<b>CAPACITÀ SERBATOIO</b> Capacité réservoir - Capacidad depósito	<b>16 kg</b>	<b>16 kg</b>
<b>USCITA FUMI SUPERIORE</b> Sortie fumées supérieur - Salida humos superior	<b>Ø 8 cm</b>	<b>Ø 8 cm</b>
<b>VOLUME RISCALDABILE</b> Volume chauffable - Volumen calentable	<b>161 m<sup>3</sup></b>	<b>216 m<sup>3</sup></b>

## PLUS

-  **STUFA ERMETICA**  
Technologie étanche  
Estufa hermética
  -  **SISTEMA CARICAMENTO BRACIERE CON COCLEA**  
Système de charge à vis sans fin  
Sistema de carga del brasero con sinfín
  -  **USCITA FUMI COASSIALE POUJOLAT**  
Sortie des fumées coaxial Poujoulat  
Salida de humos coaxial Poujoulat
  -  **BRACIERE IN INOX 316 / GHISA**  
Creuset en INOX 316 / en fonte  
Brasero en INOX 316 / en hierro fundido
  -  **SILENT ( a potenza ridotta )**  
Silence (à puissance réduite)  
Silent (a potencia reducida)
  -  **FUNZIONE ECOMODE**  
Fonction Ecomode  
Función ecomode
  -  **PROGRAMMAZIONE GIORNALIERA E SETTIMANALE**  
Programmation journalière et hebdomadaire  
Programación diaria y semanal
  -  **PREDISPOSIZIONE COLLEGAMENTO TERMOSTATO ESTERNO**  
Peut être connecté à un thermostat déporté  
Preparación para conexión a termostato externo
  -  **PREDISPOSIZIONE PER LA GESTIONE TRAMITE APP**  
Prévu pour commande via wifi  
Preparación para la gestión mediante App
-  ZONA 1    ZONA 2    ZONA 3

## OPTIONAL

-  Wi-Fi  
Wi-Fi  
Wi-Fi

## VERSIONS METAL

## VERSIONS GLASS



## CERTIFICATIONS



# CHARLY 7/9

## PELLET AIR

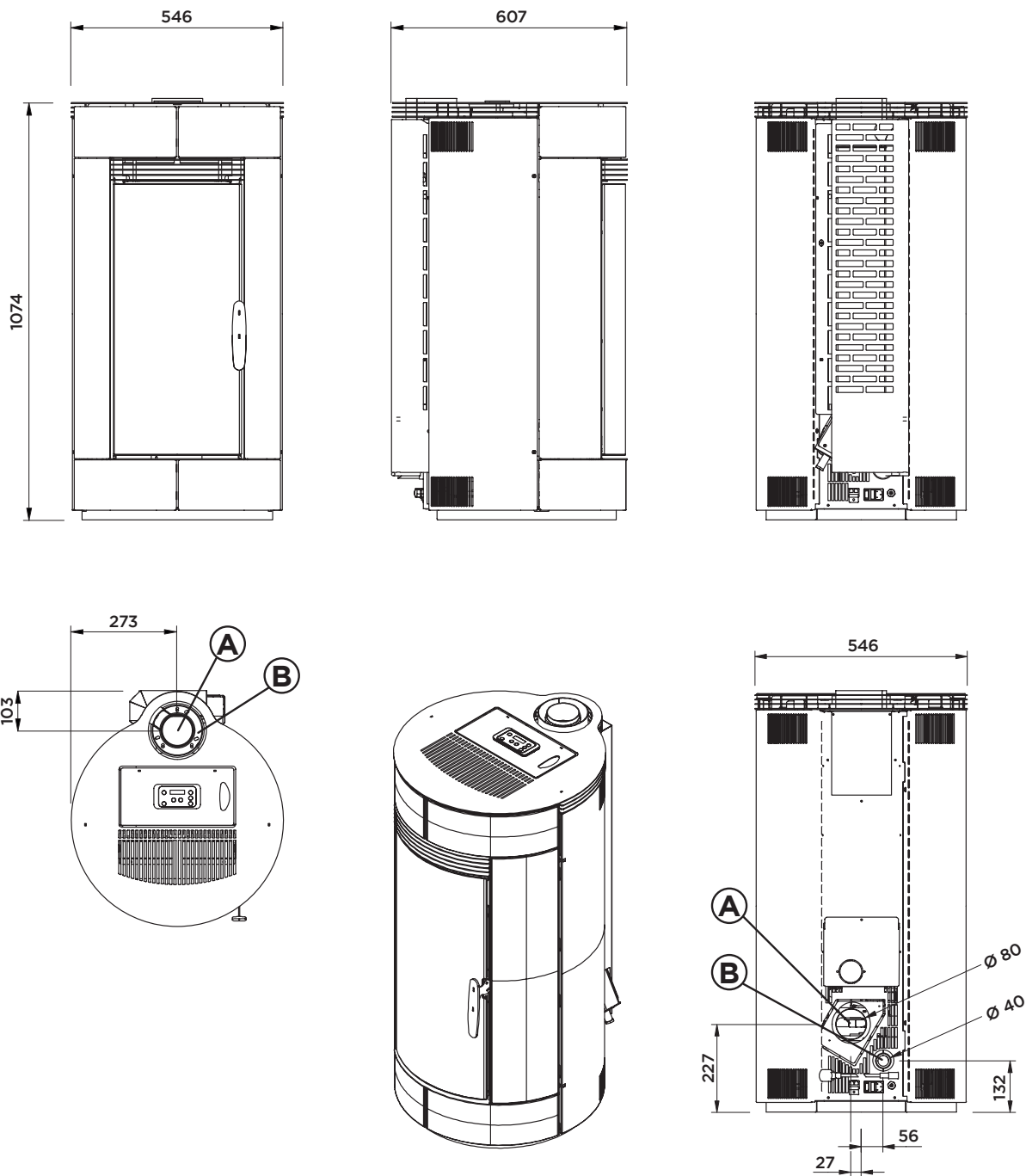

CHARLY 7/9	
Scarico fumi	A
Entrata aria comburente	B
Uscita Canalizzazione	-
Canalizzabile sino a metri lineari	

# CHARLY GLASS 7/9

CASATELLI

PELLET AIR

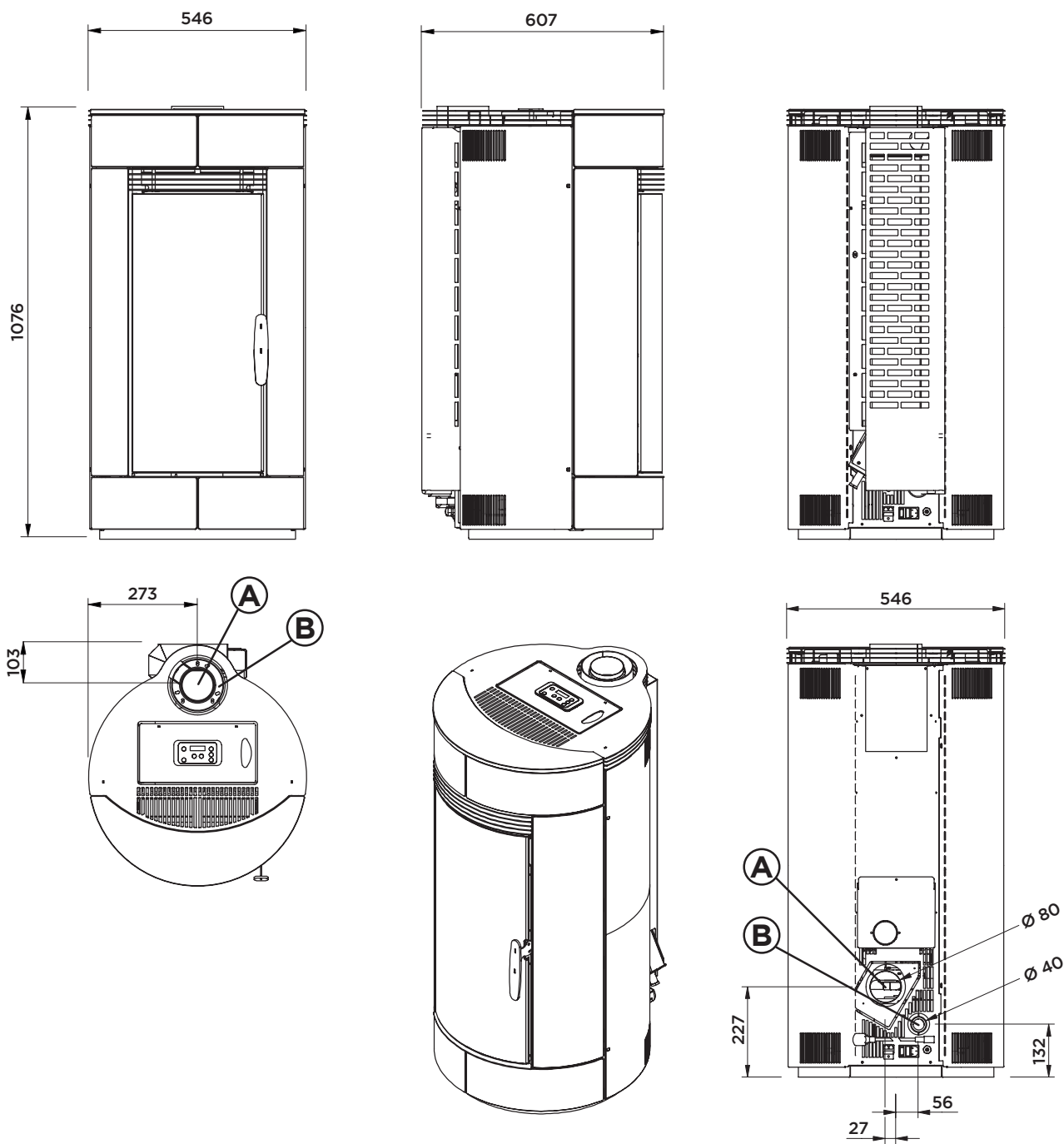

CHARLY GLASS 7/9	
Scarico fumi	A
Entrata aria comburente	B
Uscita Canalizzazione	-
Canalizzabile sino a metri lineari	